

REV.	DESCRIPTION	ENG.	APPROVAL

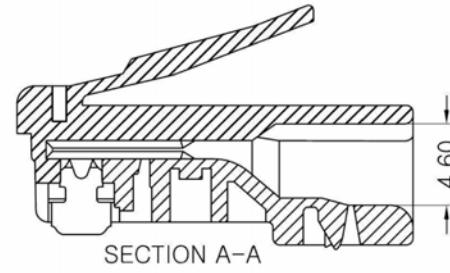

NOTES:

1. Operation Temperature: -40°C ~ +85°C.
2. Electrical Characteristics:
  - 2.1>Rated Current: 125V AC, 1.5A@25°C.
  - 2.2>Contact Resistance: 20mΩ Max.
  - 2.3>Insulation Resistance: 500MΩ Min, 100V DC/min.
  - 2.4>Voltage Proof: 1000V AC/1 minute no breakdown.
3. Mechanical Characteristics:
  - 3.1>Insertion Force & Withdrawal Force: 30N Max.
  - 3.2>Durability: 750 cycles Min.
4. Environmental compliance:
  - 4.1>the products are compliant with the RoHS, and REACH etc.

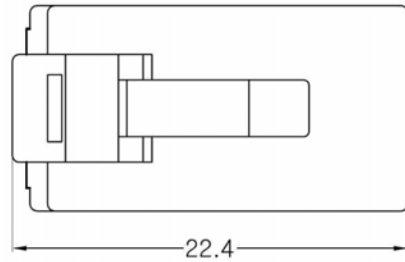
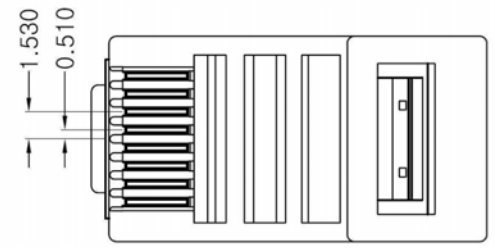
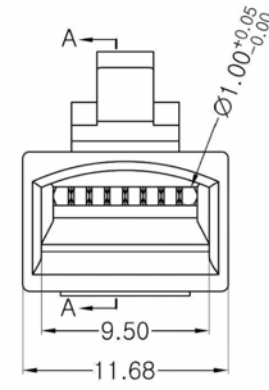
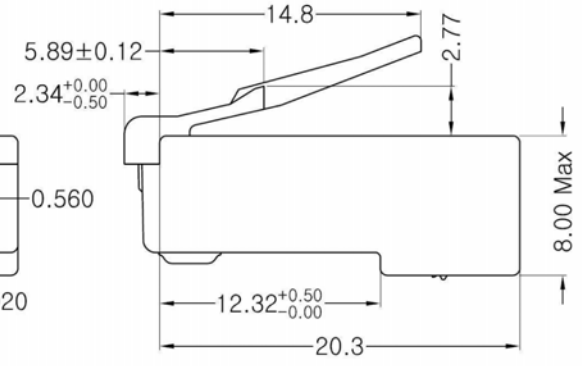
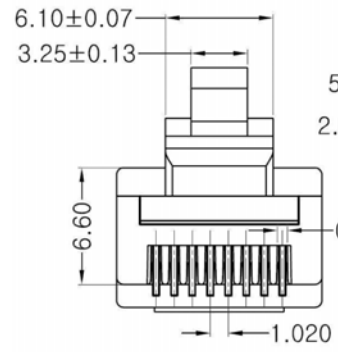

THESE DRAWINGS AND SPECIFICATIONS ARE THE PROPERTY OF INTRACOM Asia Co.,Ltd. AND SHALL NOT BE REPRODUCED COPIED OR USED IN ANY MANNER WITHOUT THE PRIOR WRITTEN CONSENT OF INTRACOM Asia Co.,Ltd.

UNLESS OTHERWISE SPECIFIED: DIMENSIONS ARE IN MILLIMETERS ANGULAR TOLERANCE: ±1°

TOLERANCE( INCH )		TOLERANCE( MM )	
x	±0.02"	x	±0.5mm
x.x	±0.01"	x.x	±0.20mm
x.xx	±0.008"	x.xx	±0.15mm
x.xxx	±0.005"	x.xxx	±0.10mm

**INTRACOM** 安達康股份有限公司  
INTRACOM Asia Co.,LTD.

TITLE:	INT Mod Plugs Cat5e UTP Stranded 100/Jar 15u"with color label	APPD	VID	102012
CUSTOMER:	Drawer	Date 2021-06-12		
CUSTOMER P/N:	Unit	mm	Projection	☉
ICT P/N: 790055	Scale	1:1	Size.	A4
DWG.NO:	Sheet	1 of	REV.	A

REV.	DESCRIPTION	ENG.	APPROVAL

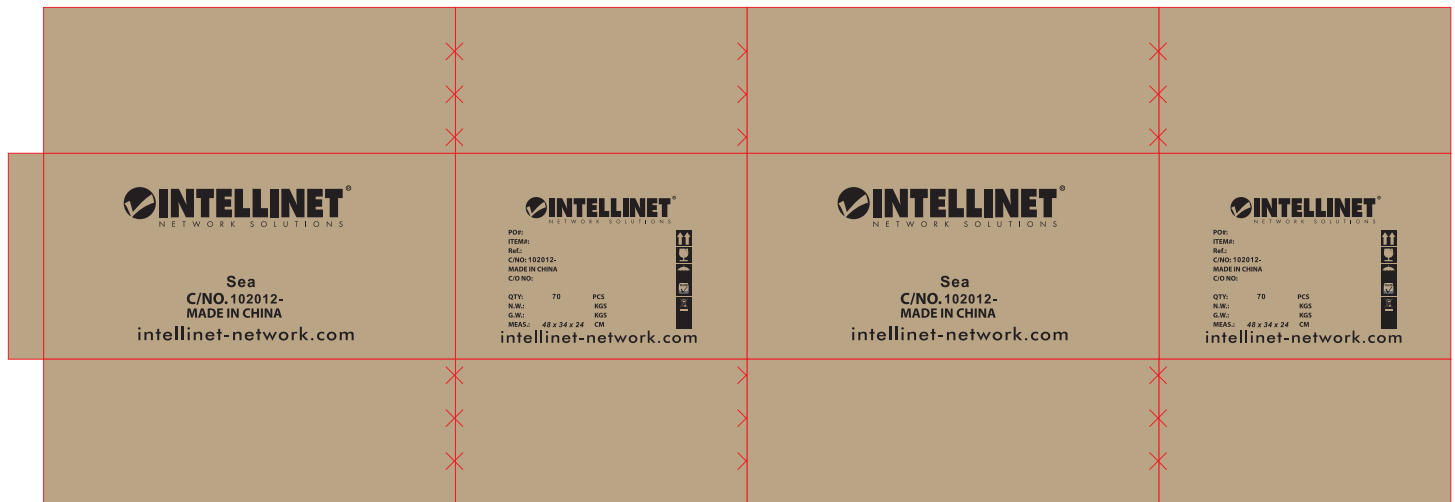

48 x 36 x 24 CM (70Jar/ Carton)

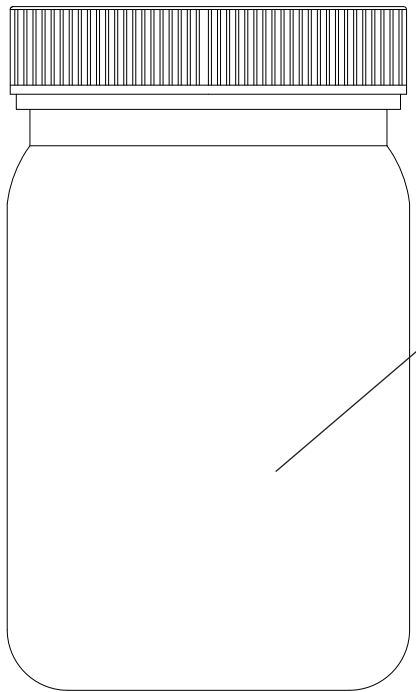

100/Jar

**English**  
**100-Pack Cat5e RJ45 Modular Plugs**  
 UTP, 2-prong, for stranded wire, 100 plugs in jar  
 • 15 µ gold-plated contacts  
 • Two-prong terminal for stranded wire  
 • Fits round cable  
 • Lifetime Warranty

**Deutsch**  
**100er Pack Cat5e RJ45 Modularstecker**  
 UTP, 2-Punkt-Aderkontaktierung, für Litzendraht, 100 Stecker pro Behälter  
 • 15 µ vergoldete Kontakte  
 • 2-Punkt-Aderkontaktierung für Litzendraht  
 • Für Rundkabel geeignet  
 • 10 Jahre Garantie

**Français**  
**Lot de 100 connecteurs modulaires RJ-45 Cat5e**  
 UTP, 2 broches, pour câble multibrin, 100 connecteurs dans un pot  
 • Contacts plaqués or 15 µ  
 • Terminaison 2 broches pour le câble multibrin  
 • Accepte le câble rond  
 • Garantie à vie

**Italiano**  
**INT Modular Plug RJ45 Cat5e UTP Standard**  
 100/Jar UTP, lamella a 2 contatti, per cavo flessibile, barattolo da 100 pezzi  
 • Contatti dorati 15 µ  
 • Lamella a 2 contatti per cavo flessibile  
 • Installabile su cavo tondo  
 • Garanzia a vita

**100-Pack Cat5e RJ45 Modular Plugs**  
 UTP, 2-Prong

**Español**  
**Plugs Modulares RJ45, Cat5e, Bote con 100 piezas**  
 UTP, 2 puntas, para cable multifilar, 100 plugs en bote  
 • Contactos con baño de oro de 15 µ  
 • Terminal de 2 puntas para cable multifilar  
 • Se ajusta a cable redondo  
 • Garantía de por vida

**Polski**  
**Wtyk RJ45 Cat5e**  
 UTP, 2-ząbkowy, linkę, słoik 100 szt.  
 • Piny pokrywane 15 µm złocieniem  
 • 2-ząbkowe piny na linkę  
 • Profil odpowiedni dla okrągłych kabli  
 • Gwarancja "Lifetime Warranty"

Intellinet Network Solutions offers a complete line of active and passive networking products. Ask your local computer dealer for more information or visit us online at [intellinet-network.com](http://intellinet-network.com)

© IC Intracom. All rights reserved. All trademarks and trade names are those of their respective owners.

Made in China  
Rev 5.01 • 790055

7 66623 179005 5

176 x 67.5 mm

THESE DRAWINGS AND SPECIFICATIONS ARE THE PROPERTY OF INTRACOM Asia Co.,Ltd. AND SHALL NOT BE REPRODUCED COPIED OR USED IN ANY MANNER WITHOUT THE PRIOR WRITTEN CONSENT OF INTRACOM Asia Co.,Ltd.

UNLESS OTHERWISE SPECIFIED: DIMENSIONS ARE IN MILLIMETERS ANGULAR TOLERANCE: ±1°

TOLERANCE( INCH )		TOLERANCE( MM )	
x	±0.02"	x	±0.5mm
x.x	±0.01"	x.x	±0.20mm
x.xx	±0.008"	x.xxx	±0.15mm
x.xxx	±0.005"	x.xxx	±0.10mm

<b>安達康股份有限公司</b> INTRACOM Asia Co.,LTD.		TITLE:	APPD	VID	102012
		INT Mod Plugs Cat5e UTP Stranded 100/Jar 15u"with color label		Check	
CUSTOMER:		Drawer	Date	2021-06-12	
CUSTOMER P/N:		Unit	mm	Projection	⊕ ⊖
ICT P/N: 790055		Scale	1:1	Size.	A4
DWG.NO:		Sheet	1 of	REV.	A